



 **Gesab**<sup>®</sup> **advantis**  
console



[scanmagnetics.com](http://scanmagnetics.com)

La tierra no puede controlarse, pero nos permite comunicarnos.

We cannot completely control the earth, but global communication is now well within reach.

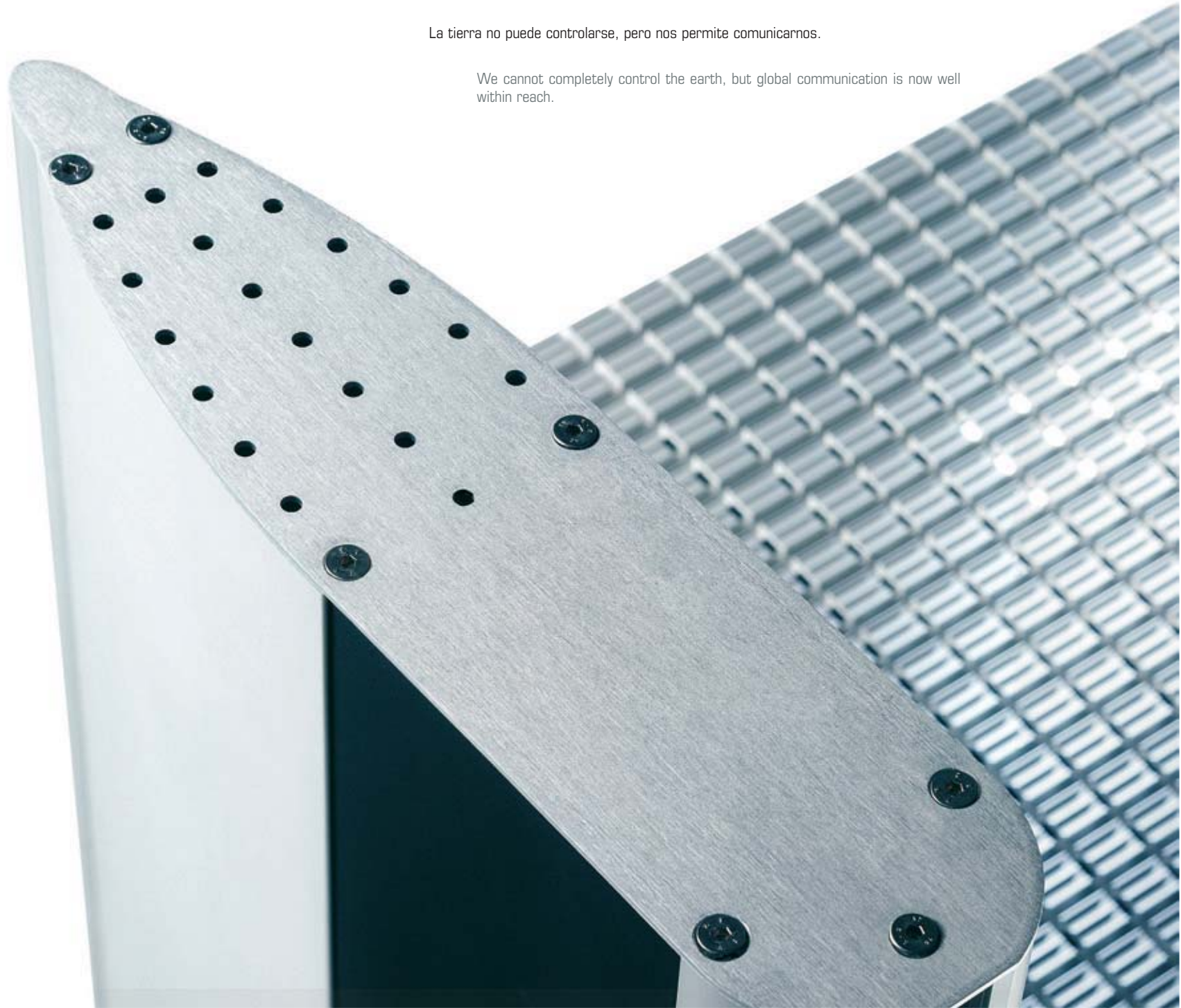



Fusionar la tecnología más avanzada con el diseño más vanguardista y con la máxima calidad, ha sido el elemento clave en el proceso de innovación de ADVANTIS, reflejo de la naturaleza que nos rodea, buscando la perfección en cada momento y situación.

The key element in the ADVANTIS's development has been the marriage of the most advanced technology in modular office systems and it's most up to date, modern appearance all to the highest standard. Our aim has been to reflect nature, in the way that it meets every requirement in an ever changing world, like that of modern business.



La tierra está en constante movimiento, orbita, gira, se desplaza...

The earth is moving constantly; turning and orbiting. In short it is continually adapting to changing demands and circumstances...

... en definitiva, se adapta, al igual que todos los sistemas y elementos de la serie ADVANTIS

...this is a concept we have transferred to all the components and systems of the ADVANTIS.





La superficie terrestre es de casi 150 millones de kilómetros cuadrados las nuevas tecnologías permiten controlarla casi al milímetro, pero es necesario tener una configuración ADVANTIS para realizarlo.

The earth's surface is almost 150 million square kilometers and new technology makes it possible to cover it with pinpoint precision. An ADVANTIS system is indispensable, in ensuring that this ideal becomes a reality.

La tierra posee un diámetro de 12.753 Km y la gravedad ha hecho que sea redonda, su forma ha inspirado el diseño de elementos y detalles de la consola.

The earth has a diameter of 12.753 Km, gravity has made it round, its shape has inspired the elements and details of the console's design.

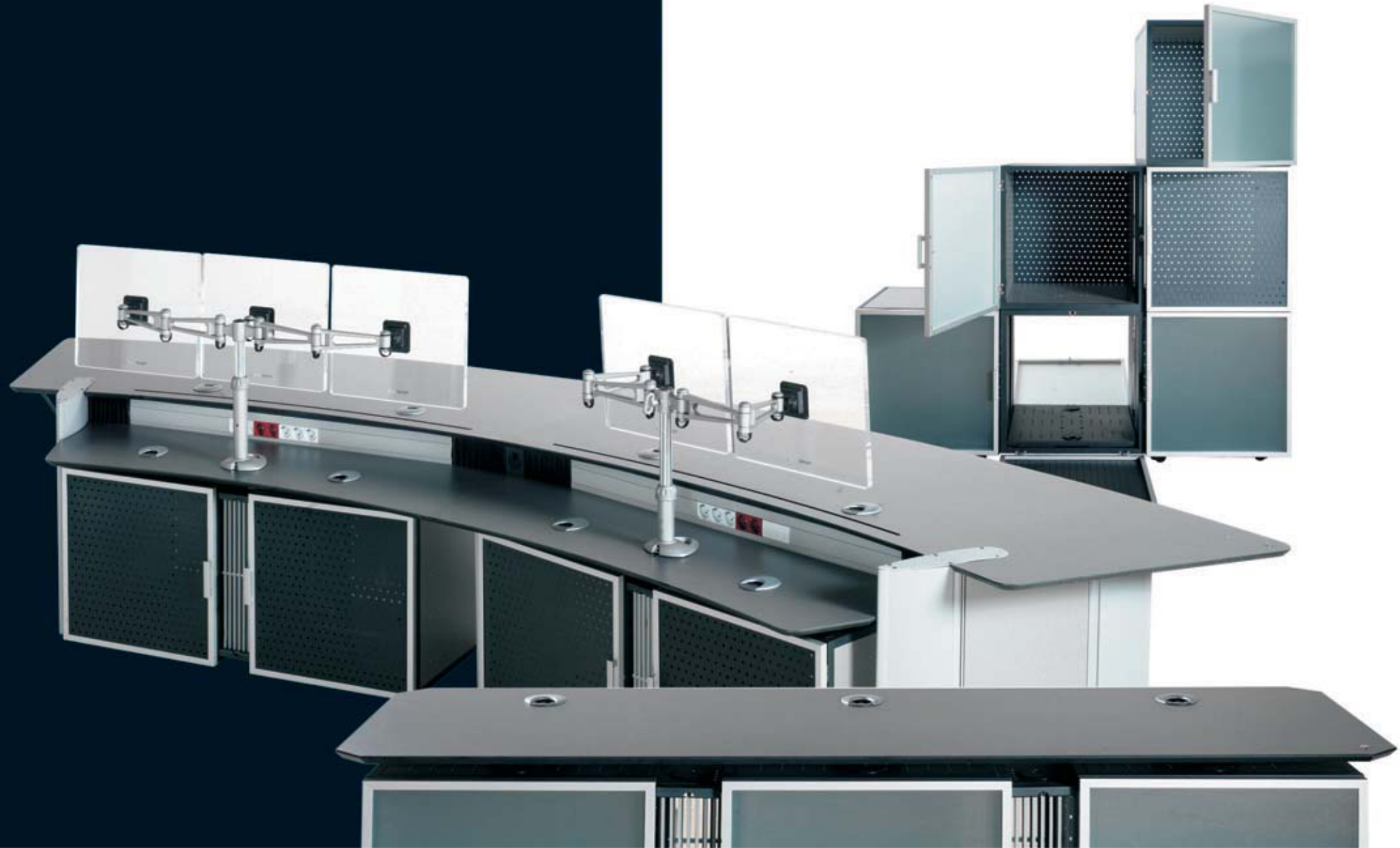



Sólo la naturaleza supera en ergonomía a ADVANTIS, diseñado bajo las más exigentes normativas, cuidando cualquier detalle por insignificante que parezca.

Only Mother Nature herself can surpass the ADVANTIS, in terms of ergonomics. It has been designed to the most exacting standards, with care and attention lavished on even the smallest detail.





Un mundo de comunicación... un sistema de organización.

To achieve effective world wide communication... you need an advanced organization system.







Es imposible superar la infinidad de formas, colores y materiales que hay en nuestro planeta, pero nos acercamos gracias a la flexibilidad, modularidad y adaptabilidad, capaz de satisfacer cualquier necesidad, estética y funcional, por exigente que sea.

It is impossible to surpass the variety of shapes, colors and materials that are present in the world of nature. However at Gesab, we have come very close, thanks to the flexibility, modularity and adaptability of the ADVANTIS. We are now able to meet all your requirements of a console, both functional and aesthetic, no matter how complex or demanding.



# advantis console

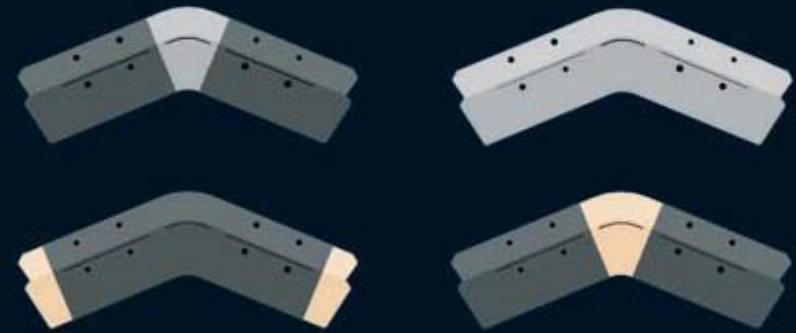



Aproximadamente el 71% de la superficie del planeta se encuentra cubierta por agua. La combinación de materiales de última generación con la pureza del cristal y unido a la tecnología más avanzada, permite crear soluciones innovadoras y con un alto valor añadido.

Approximately 71% of the Earth's surface is underwater. Combining the latest materials with crystal clear vision and the most up to date technology, we are able to create innovative system solutions with real added functional dimension.





El Everest con 8.848 metros de altitud, es el punto más alto de la tierra...

...ADVANTIS permite crecer en altura y aprovechar al máximo el espacio vertical .

Everest, at 8.848 m, is the Earth's highest point. The ADVANTIS console enables the users console...

...to grow in height and saturate in order to make best use of vertical office space.





Canalización del Cableado  
Cable Channeling

Conducción Principal  
The Main Unit



Conexiones de Superficie  
Surface Mounting

Área Técnica de Servicio  
Technical Service Area



Los cuatro elementos: agua, aire, tierra y fuego están totalmente relacionados para armonizar la vida en el planeta. ADVANTIS Console une las cuatro técnicas empleadas para la organización y administración de todo el cableado y conexionado.

- Conexiones de Superficie.
- Área Técnica de Servicio.
- Conducción Principal.
- Canalización del Cableado.

The four elements: water, air, earth, fire are in intrinsically linked, thus ensuring harmony on our planet. The ADVANTIS Console unites the four main areas below, for optimum organization and administration of all connections and cabling.

- Surface Mounting.
- Technical Service Area.
- The Main Unit.
- Cable Channeling.

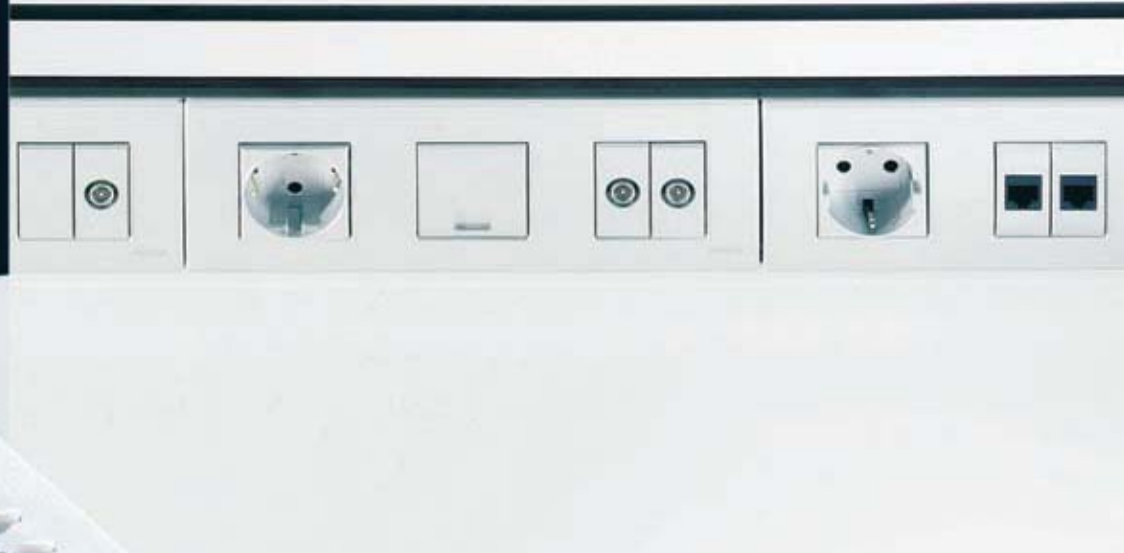



Una estricta selección de los materiales empleados, la utilización de innovadores procesos de producción y los más exigentes controles de calidad, nos permiten ofrecer en exclusiva 10 años de garantía.

By means of careful selection of materials, together with innovative production processes as well as the most exacting of quality control, we are able to offer an exclusive 10 year guarantee.

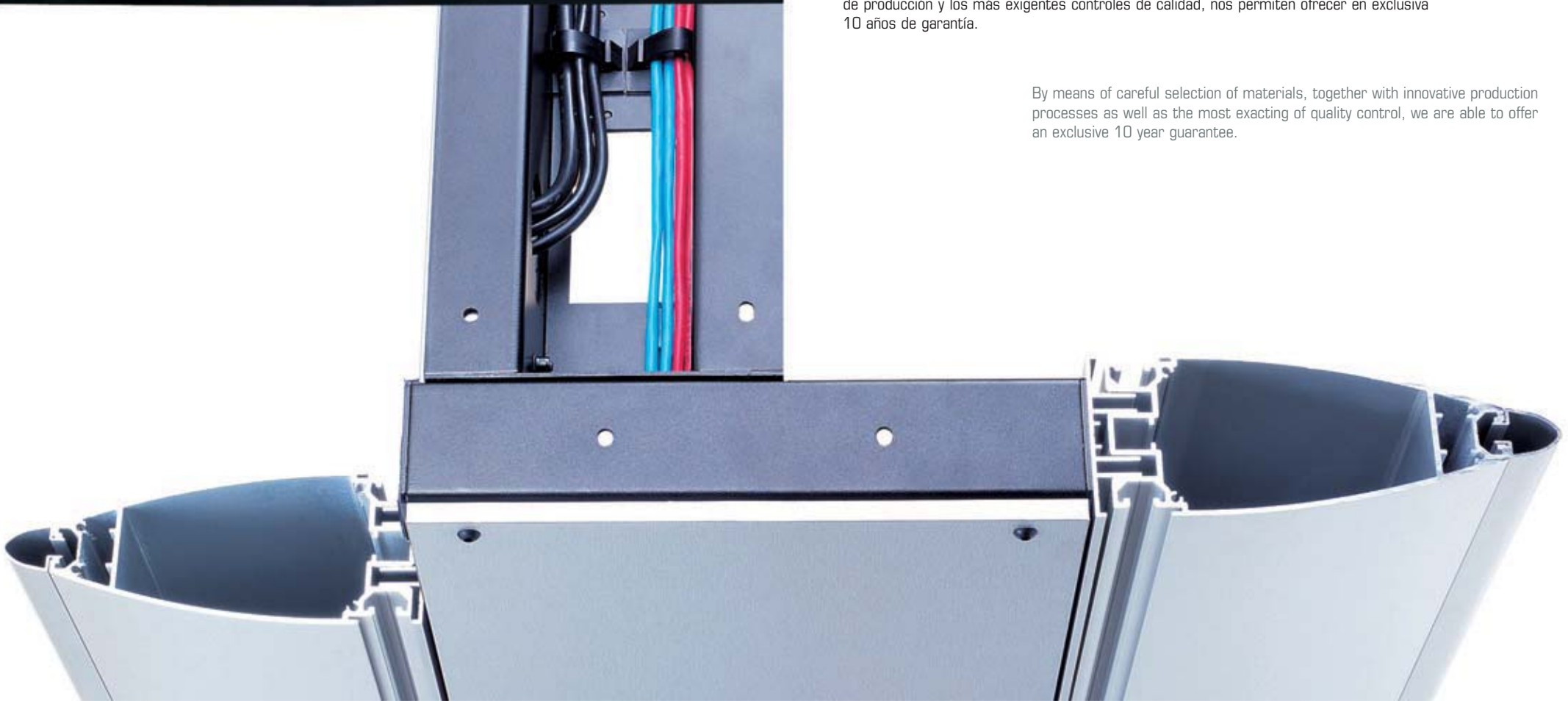









FORMAT		CLASS	N° UPRIGHTS	TYPE	MODEL	MEASURE	1 CONFIGURATION CHART	
1" TABLE HEIGHT		RECTANGULAR	3 UPRIGHTS	INDIVIDUAL	STANDARD	1200MM 1600MM 1800MM	CONTROL CONSOLE	MANAGING CONSOLE
					CONTROL		LINEAL CONSOLE	
LOWER LEVEL		RECTANGULAR	3 UPRIGHTS	CONTINUAL	More than one lineal configurations. Middle upright is shared, they are compatible with all measurements in all formats.		CONCAVE CONSOLE	CONCAVE CONSOLE
					4 UPRIGHTS	CONVEX CONSOLE		
SPLIT LEVEL		CURVED	3 UPRIGHTS	CONTINUAL	CONCAVE CONVEX	15° 30° 45° 60°	CONVEX CONSOLE	MIXED CONSOLE CONVEX
					MIXED		MULTIPLES CONCAVE CONVEX	
	CURVED	CURVED	4 SMALL UPRIGHTS	CONTINUAL	CONCAVE CONVEX	15° 30° 45° 60° 90°	CONSOLE 90° CONVEX	MULTIPLE MIXED CONSOLE
				MIXED	MULTIPLES CONCAVE CONVEX		MIXED	
			4 HIGH UPRIGHTS	CONTINUAL	CONCAVE CONVEX	90		
				MIXED	MULTIPLES CONCAVE CONVEX			

CABINETS COMPATIBILITY UNDER REAR SHELF		LOCKABLE CABINETS					
TYPE OF CONFIGURATION	DIMENSIONS	DRAWERS CABINETS	SINGLE CABINET	DOUBLE CABINETS	TRIPLE CABINETS	MANAGING CABINET	
LINEAL	1200	Mobile Cabinet	Mobile Cabinet	•	•	auxiliary furniture	
	1600	Mobile Cabinet	Centre / left or right. Mac: 2	•	•	auxiliary furniture	
	2000	Mobile Cabinet	Centre / left or right. Mac: 3	Centre / left or right. Mac: 1	•	auxiliary furniture	
MANAGING	2300 aluminium plate	Mobile Cabinet	Mobile Cabinet	Rear area	Rear area	Integrated under peninsula	
	2300 shelf	Mobile Cabinet	Centre / left or right. Mac: 3	Centre / left or right. Mac: 1	•	Integrated under peninsula	
CURVED	CON   CONV		<b>OBSERVATIONS:</b>				
	15°	Mobile Cabinet	The positioning of the lockable cabinets in curved configurations, concave or convex, is exactly just as in lineal configurations. The topology of cabinets is in relation to the width of the used structure.				auxiliary furniture
	30°	Mobile Cabinet					auxiliary furniture
	45°	Mobile Cabinet					auxiliary furniture
60°	Mobile Cabinet	auxiliary furniture					
CONSOLE 90°	Concave	Mobile Cabinet	•	•	•	auxiliary furniture	
	Convex	Mobile Cabinet	•	•	•	auxiliary furniture	

AL=ALUMINIUM  
 AC=STEEL  
 AG=PLYWOOD  
 FE=PHENOLIC  
 PL=PLASTIC

LOCKABLE CABINETS		ACCESSORIES												
		Structure	Fixed Base Shelf	Sliding Base Shelf	19" Sections	Technical Service Area	Front Door Glass 4mm	Vented Rear Door	Sliding Door	External Covers	Rear Cover	Drawers	Sockets / Data	Castors Kit
DRAWERS CABINET		*	*	*	*	*	*	*	*	*	*	*	*	*
		1	-	-	-	-	-	-	-	2	1	3	-	4W.
SINGLE CABINET		*	*	*	*	-	*	*	-	*	-	-	Yes	*
		1	3	1	1	-	1	1	-	2	-	-	Yes	4W.
DOUBLE CABINET		*	*	*	*	*	*	*	*	*	*	*	Yes	*
		2	6	2	2	1	2	2	-	2	-	-	Yes	8W.
TRIPLE CABINET		*	*	*	*	*	*	*	*	*	*	*	Yes	*
		3	9	3	3	2	3	3	-	2	-	-	Yes	12W.
MANAGING CABINET		*	*	*	*	*	*	*	*	*	*	*	Yes	*
		1	9	3	3	2	-	-	1	2	1	-	Yes	5W.
COLOUR	AC=NOIR 200 SABLE				FE: ON REQUEST. BLUE									
	AL=ANONIZING SILVER				White / Light Grey / Blue									
	AL=ALUMINIUM SOFT													
MATERIAL	AL	AG AC	AC	AC	AC AL	AL	AL AC	AL	AG AC	AG	FE AG	-	PL	



El respeto al medio ambiente es nuestra mejor apuesta en el presente para una garantía de futuro.

Quality and environment is our commitment to a guarantee for the future.